

HK2516-AS1-B

Drawn cup needle roller bearing open end

Schaeffler ID:
0037375350000

Drawn cup needle roller bearing open end
HK...AS1-B, single row, with cage

Technical information

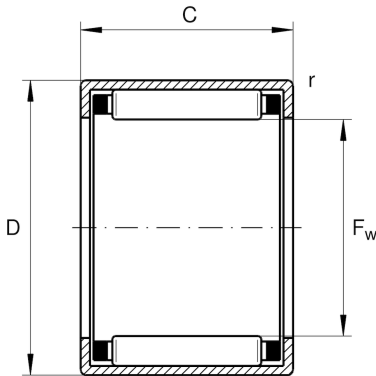

Main Dimensions & Performance Data

F_w	25 mm	Under roller diameter
D	32 mm	Outside diameter
C	16 mm	Width
C_r	15.600 N	Basic dynamic load rating, radial
C_{0r}	24.000 N	Basic static load rating, radial
C_{ur}	3.200 N	Fatigue load limit, radial
n_G	10.200 1/min	Limiting speed
$n_{G \text{ Grease}}$	6.100 1/min	Limiting speed for grease lubrication
n_{gr}	7.500 1/min	Reference speed
	25,845 g	Weight

Dimensions

r_{\min}	0,8 mm	Minimum chamfer dimension
------------	--------	---------------------------

Temperature range

T_{\min}	-30 °C	Operating temperature min.
T_{\max}	140 °C	Operating temperature max.

Additional information

	SD25X32X4	Sealing ring
	G25X32X4	Sealing ring 2
	LR20X25X16,5	Suitable inner rings LR
	IR20X25X17-XL	Suitable inner rings IR